



Corporate Presentation

Disclaimer

The contents of this presentation are for informational purposes only and for the reader's personal non-commercial use. The contents are intended but not guaranteed to be correct, complete or absolutely accurate. This presentation also contains forward-looking statements based on the currently held beliefs and assumptions of the Management of the Company, which are expressed in good faith and in their opinion are reasonable.

Forward looking statements involve known and unknown risks, contingencies, uncertainties, market conditions and other factors which may cause the actual results, financial condition, performance or achievements of the Company or industry results to differ materially from the results, financial condition, performance or achievements expressed or implied by such forward-looking statements. The Company disclaims any obligation or liability to any person for any loss or damage caused by errors or omissions whether arising from negligence, accident or any other cause.

Recipients of this presentation are not to construe its contents or any prior or subsequent communications from or with the Company or its representatives as investment advice. In addition, this presentation does not purport to be all inclusive or to contain all the information that may be required to make a full analysis of the Company and of the relevance and adequacy of the information and should make such other investigations as they deem necessary.

Company Snapshot



1975

Commenced operations in Coimbatore, INDIA.



470 +

Product & Process Engineers



IATF 16949:2016, ISO14001:2015, ISO 45001:2018, ISO/IEC 17025:2017 and ISO/IEC 27001:2022
(Obtained ISO 9001 in the year 1993)



8,500 +

Employees
(Including Subsidiaries)



2

Technology Centers
(~ 4.5% of Total revenue spent on R&D)



40,523.70 INR Million

(426.56) USD Million

FY26 Consolidated Total Income



15

Manufacturing Plants
(Including Subsidiaries)



5

Presence in India, Indonesia, Singapore, Japan and Dubai.



Top 100

Industrial Innovation Awards 2025
Awarded by CII



6

Key Strategic Partnerships



16

Countries Direct OEM Supplies



100%

Energy Consumption via Renewable Sources.
(Excluding Diesel Generator)

Our Presence

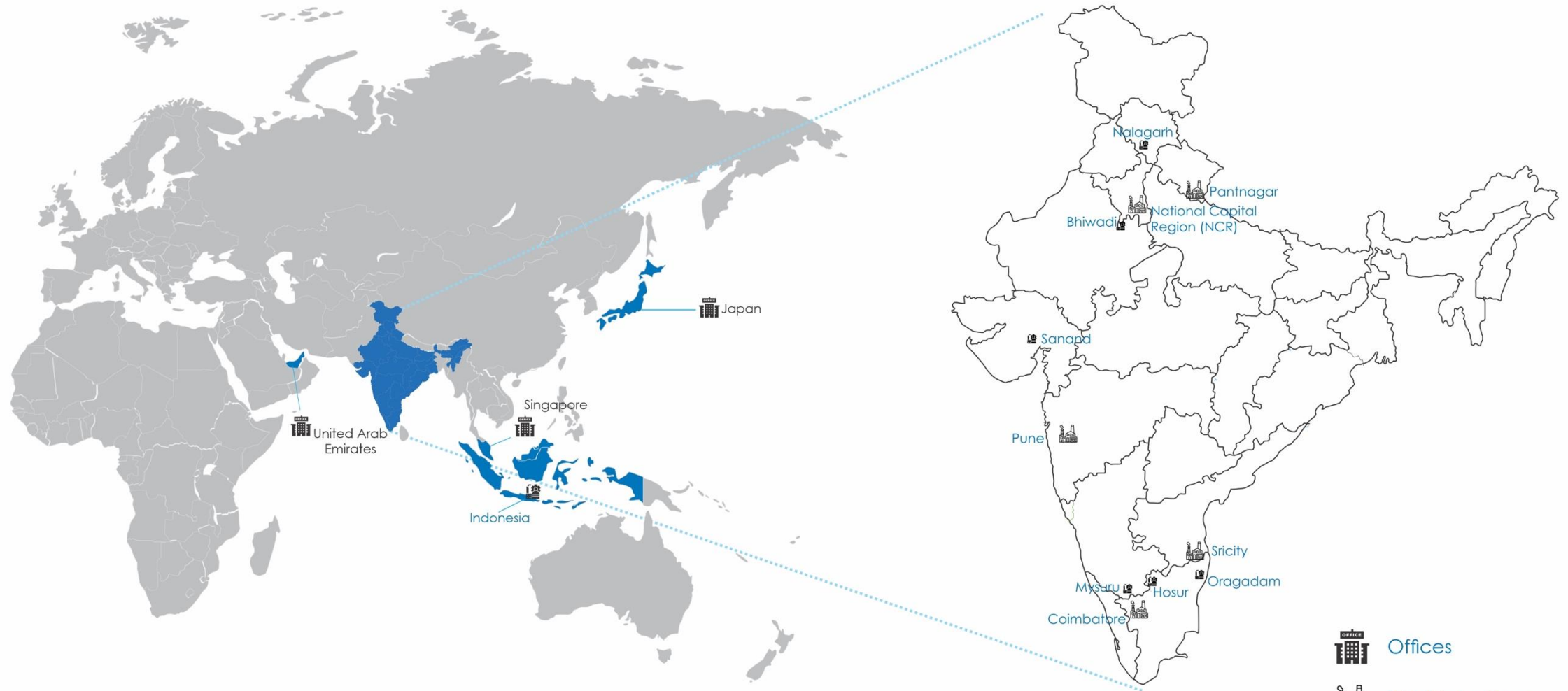

-  Offices
-  Plant Locations
-  Subsidiary Plants

Our In – House Capabilities



ENGINEERING EXCELLENCE

470+ Product and Process Engineers
Subject Matter Experts in Electronics
(Hardware & Software), Mechanical and
Electro-Mechanical domains
ASPICE level 2 practices

MANUFACTURING EXCELLENCE

PCB Assembly with SMT Lines
Robotic Lines with EOL Testing
State of the art Tool Room
Plastic Injection Molding
Pressure Die Casting
Machine Building
Sintering

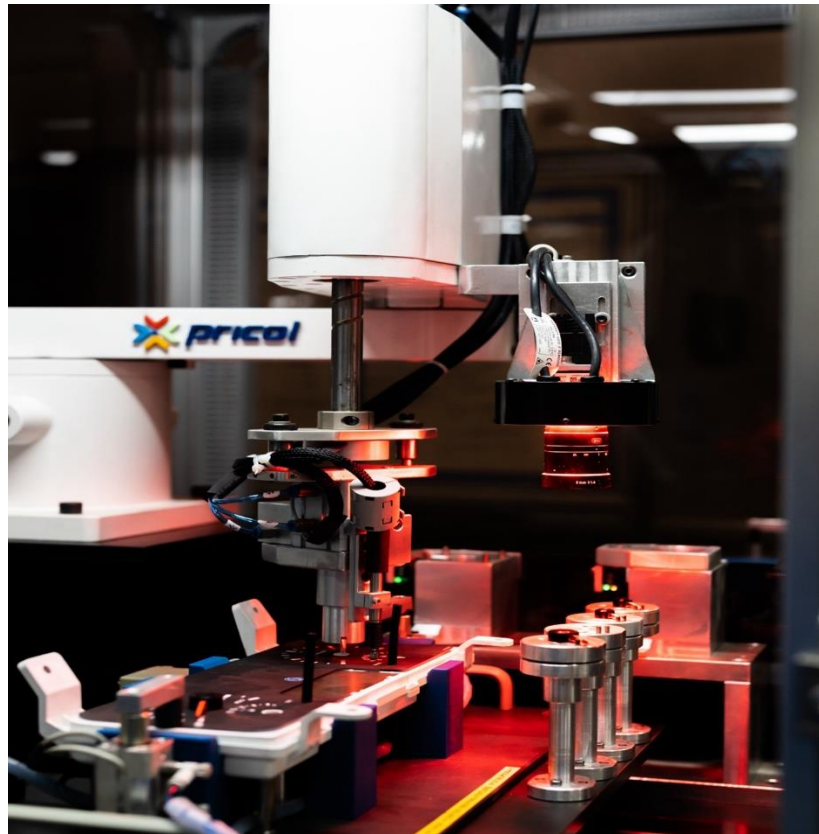

TESTING EXCELLENCE

EMI – EMC
Hil and Sil Lab
Environment
Endurance
Product Reliability (NABL Accredited)



Product Verticals

A. Driver Information and Connected Vehicle Solutions



E-Cockpit



TFT Cluster

LCD Cluster



Hybrid Cluster

Heads up Display (HUD)

Telematics



Reed Type Fuel Level Sensor

TFR Type Fuel Level Sensor



Battery Management System

B. Actuation, Control and Fluid Management System



Electrical Oil Pump

Electrical Coolant Pump

Oil Pump



Disc Brake System

Coolant Pump



Electronic Switches

Throttle



Clutch Lever

Grip

Break Lever



Cabin Tilt System

Fuel Pump Module

Electronic Purge Valve

C. Precision Products



Dash Board Assembly



Piece Radiator

Radiator Grill



Roof Rack



Garnish with DAB

DAB Cover

Dash Board



Windshield

Front Finisher

Fuel Tank



Air duct

Garnish

Decoring

Our Major Customers



Recent Partnership

Key Partnerships



Sibros' connected all-in-one platform will complement Pricol's suite of products on Driver Information Systems (DIS) and **Telematics** to offer **end-to-end solutions** to the OEMs. The cloud-based platform of Sibros, combined with the next generation products of Pricol, will enable features such as OTA software and firmware updates, vehicle data insights for analytics, diagnostics and troubleshooting for the OEMs to make the best use of the connected solutions.



Entered into an International licensing agreement with BMS PowerSafe, a part of Startec Group to manufacture and sell **Battery Management System (BMS)** for Indian Market. In this partnership, Pricol will be licensing the product and process technology of BMS from Partner and will be manufacturing complete BMS in-house. This partnership has opened up a new arena for Pricol to add a pure play EV product in our portfolio. The company is recognized as the top 3 pure players of BMS suppliers in Europe.



Pricol in partnership with PSG Institutions has launched a **Center of Excellence (CoE)** to develop high efficiency **micro motors and Robotics and artificial Intelligence** based processes and equipment. With Pricol's strong foot print in product domain and customer connect and PSG Institutions' expertise in first principle fundamentals, the CoE will certainly benefit the community at large to come out with world class new technology products and processes.



Pricol is partnered with CGI studio for **Human Machine Interface (HMI) Solutions** Candera will, help in HMI solutions with shorter lead time, cost effective solutions – all made possible by having a single HMI tool to support Next Generation Display Systems to be built on various Product Platforms which is indigenously developed by Pricol.



Pricol has partnered with Heilongjiang Tianyouwei Electronics (TYW) for **advanced technologies** in **Driver Information System Solutions across various vehicle segments**. This partnership is set to redefine the driving experience by introducing cutting-edge Driver Information System Solutions such as e-cockpit and Heads-up Displays. The collaboration will add value to the Indian automotive landscape by combining Pricol's domain expertise in Driver Information System with TYW's technological prowess.



Pricol Limited has entered into a **Technology License Agreement** with Italy-based DOMINO S.R.L., a global leader in motorcycle control systems. This partnership aims to **expand advanced two-wheeler handlebar control technologies such as throttles, switches, and allied products** across India and Southeast Asia, marking a pivotal step in Pricol's innovation-driven growth strategy.



Key Highlights



Confederation of Indian Industry



Global Summit on Technology, R&D and Intellectual Property

From Dependence to Innovation: Resilient Growth for Atmanirbhar Bharat



Top 100 Innovative Companies Award on 16-Dec-2025

Confederation of Indian Industries (CII) awarded Pricol as one of the "TOP 100 INNOVATIVE COMPANIES"
as a part of Industrial Innovation award 2025





Confederation of Indian Industry



Global Summit on Technology, R&D and Intellectual Property

Fr...penden...omir...ch, D...Tech...Bhar...



Top 25 Companies Excelling Women in STEM on 17-Dec-2025

Confederation of Indian Industries (CII) awarded Pricol as one of the "TOP 25 COMPANIES" as a part of Excelling Women in STEM (Science, Technology, Engineering, and Mathematics) Award 2025





ACMA-AMF Cluster Star Performer Award 2025 on 04-Mar-2025

Outstanding performance in ACMA-AMF Cluster Program under the TPM category, "ACMA-AMF Cluster Star Performer Award 2025" ACMA Mobility Foundation Delhi

Annual Summit on Technology, Intellectual Property, and Industry-Academia Partnerships

'Shaping the Decade: Empowering Global Growth through
Technology and Industry-Academia Partnerships'

13 December 2024

New Delhi



Top 75 Innovative companies on 13-Dec-2024

Confederation of Indian Industries (CII) awarded Pricol as one of the "TOP 75 INNOVATIVE COMPANIES" as a part of Industrial Innovation award 2024

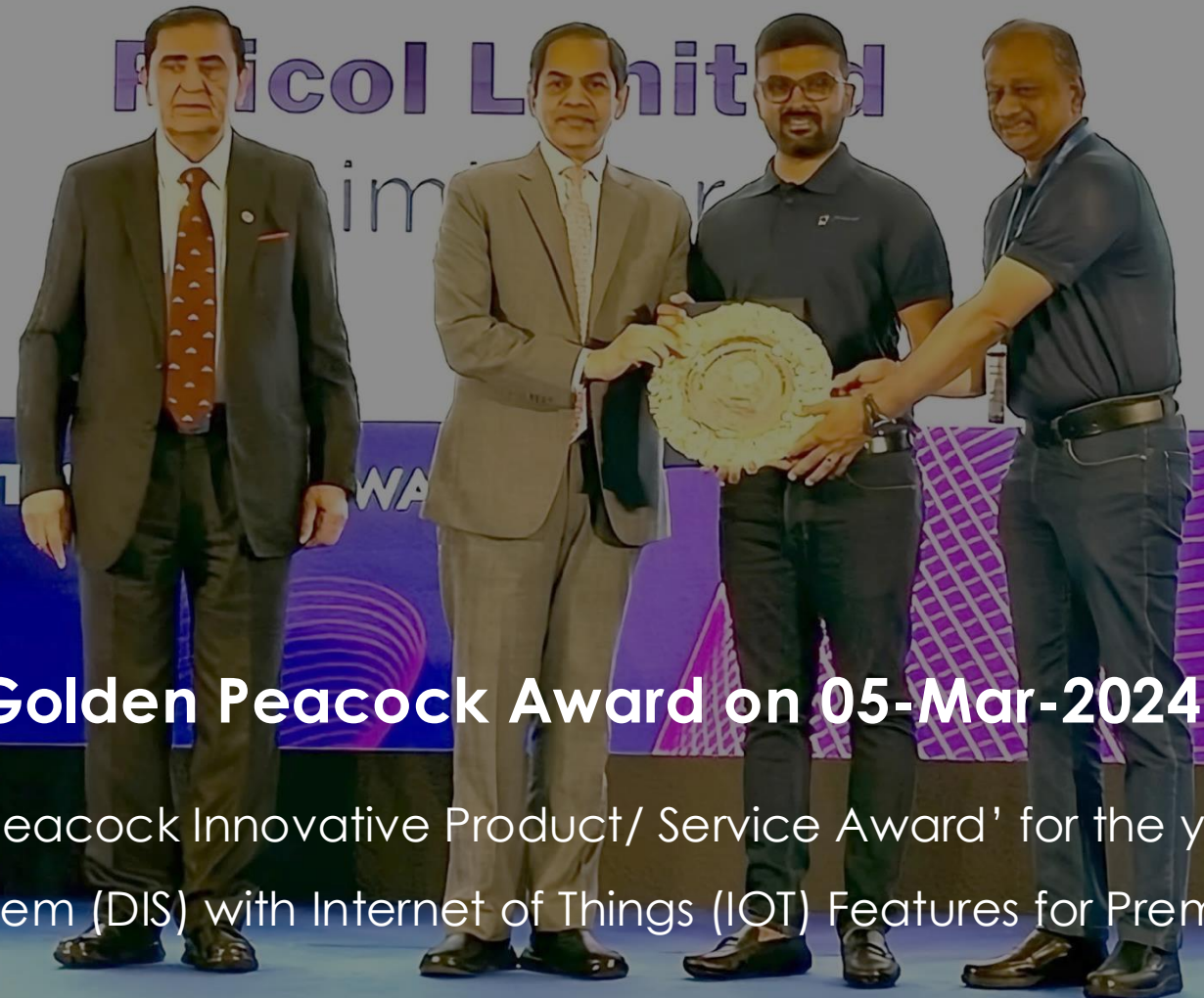

Golden Peacock Award on 05-Mar-2024

Winner of 'Golden Peacock Innovative Product/ Service Award' for the year 2024 (for Driver Information System (DIS) with Internet of Things (IOT) Features for Premium Scooters)





Top 50 innovative companies on 20-Dec-2022

Confederation of Indian Industries (CII) awarded Pricol as one of the "TOP 50 INNOVATIVE COMPANIES" as a part of Industrial Innovation award 2022

EXCELLENCE IN NEW MODEL COST & DEVELOPMENT

WINNER



Award from Honda Motorcycle and Scooter India on 06-March-2026

Award received under the category "Excellence in New Model Cost & Development Award" at
Honda Annual Supplier Convention 2026

TATA MOTORS
Connecting Aspirations

ANNUAL SUPPLIER CONFERENCE 2025
TMPV & TPEM

INNOVATION & TECHNOLOGY EXCELLENCE



Award From TATA Motor on 19-Sept-2025

Award received under the category "Innovation & Technology Excellence" at TMPVL & TPEML Annual Supplier Conference 2025.



GLOBAL SUPPLIER
MEET 2025

HERO INNOVATION LEADER



Award From Hero Motor Corp on 17-Sept-2025

Award received under the category "Hero Innovation Leader" at Global Supplier Meet 2025.





Award From Caterpillar on 21-August-2025

Award received under the category "Supplier Excellence Recognition 2025" at Caterpillar Annual Program.



Award From Ather Energy on 20-Jun-2025

Pricol Precision Products Private Limited (P3L) has been honored with the prestigious "Excellence in Business Competitiveness" award by Ather Energy at their Annual Supplier Meet 2025.

SPECIAL SUPPORT IN SUPPLY CHAIN



PRICOL LTD.

Award From Suzuki Motorcycle India Limited on 19-May-2025

Award received under the category "Special Support In Supply Chain" at Annual Vendor Conference 2025.

Consecutively Awarded as the Best Supplier from Suzuki Motorcycle India Private Limited (SMIPL) for 4 years in a Row.





Award From Daimler Trucks on 05-Dec-2024

Award received under the category "Quality-Zero PPM & 100% Delivery" for reliable partner for the year 2023

TATA MOTORS
ANNUAL SUPPLIER CONFERENCE 2024
COMMERCIAL VEHICLES

SUSTAINABILITY EXCELLENCE
PRICOL



Award TATA Motors on 26-Sep-2024

Award received under the category "Sustainability Excellence" at Annual Supplier Conference 2024

ESG Champion of the year
Gold Award Winner
PRICOL LIMITED



Award From Ashok Leyland on 26-Jul-2024

Gold Award received under the category "ESG Champion of the year" at Annual Vendor Conference 2024



TVS

Pricol Team Pump Div



CFT Team Members :

Facilitators



Mr. Sundaresan
Head-Plant Operation



Mr. Suresh
Head - Engineering

Team Me



Mr. Arun Prasad
Customer Quality



Mr. Muthukumar
ETG



PQA-QAD

Slide 3



Award From TVS Motors on 28-June-2024

Award received under the category "Best Reliability Cluster" for the BLDC fuel pump module



AWARDS ANNUAL SUPPLIER CONFERENCE 2024

Congratulations

BEST DELIVERY

PRICOL LTD.



Award From Suzuki Motorcycle India Limited on 27-May-2024

Award received under the category "Best Delivery Management" at Annual Vendor Conference 2024.

AWARDS ANNUAL SUPPLIER CONFERENCE 2024

Congrat

FINANCIAL PRUDENCE

PRICOL LTD



Award From Suzuki Motorcycle India Limited on 27-May-2024

Award received under the category "Financial Prudence" at Annual Vendor Conference 2024



Award From Tata Motors on 15-Dec-2023

Gold Award received from Tata Motors for "ED's DWM Cup Assessment"



ANNUAL SUPPLIER CONFERENCE

2023 | INDIA

BEST QUALITY PERFORMANCE



Award From JCB on 01-Dec-2023

Award received from JCB for "Best Quality Performance" at the Supplier Meet 2023



TECHNOLOGY & INNOVATION



Award From Daimler Truck on 25-Oct-2023

Award received from Daimler Truck for "Technology and Innovation" at the Annual Supplier Meet 2023



Award From TVS Motor on 25-Aug-2023

Award received under the category "Supplier Reliability Cluster Program" for JUPITER Fuel Pump warranty reduction through Reliability Improvement Methodology – BEST COST SAVING

MOVE THE WORLD FORWARD MITSUBISHI
HEAVY
INDUSTRIES
GROUP

BREATHING LIFE INTO MACHINES

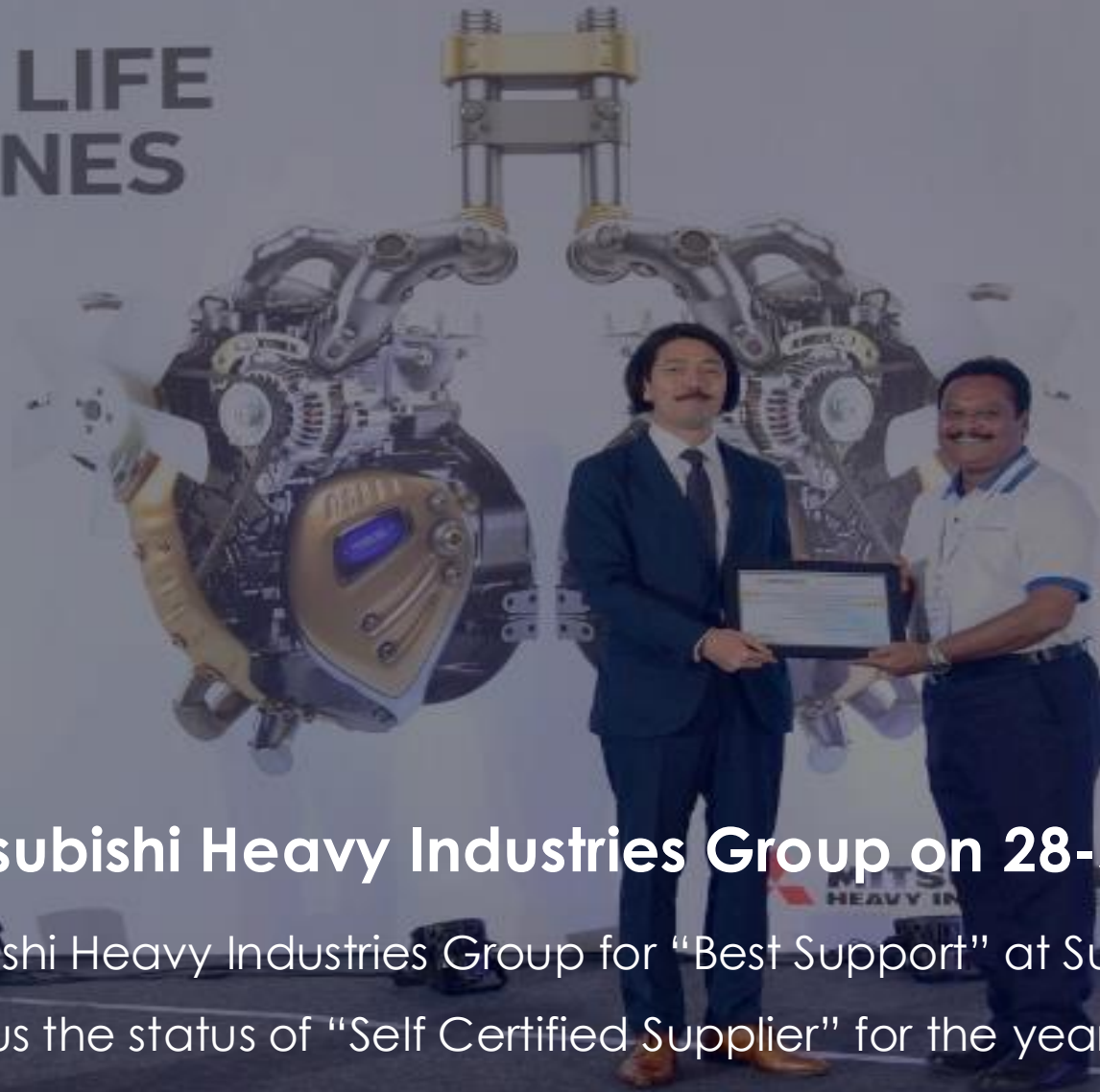

Award From Mitsubishi Heavy Industries Group on 28-July-2023

Award received from Mitsubishi Heavy Industries Group for "Best Support" at Supplier Conference.

Also awarded us the status of "Self Certified Supplier" for the year FY24.

Supplier Samrat National Runner up in Proprietary 2022 - 23



Award From Ashok Leyland on 23-Jul-2023

Award received from Ashok Leyland for "Supplier Samrat - National Runner Up in Proprietary" at Supplier Summit 2023.



Award From Suzuki Motorcycle India Limited on 28-Jun-2023

Award received under the category "Best Supply Chain Management" at Annual Supplier Conference 2023.

DELIVERY MANAGEMENT FUNCTIONAL MEDIUM & SMALL FARMS



AWARD FROM HONDA MOTORCYCLE AND SCOOTER INDIA on 16-Mar-2023

Award received from Honda Motorcycle and Scooters India "Best Delivery Management"
at Annual Supplier Conference.

BEST IN INNOVATION & TECHNOLOGY



Award From Hero MotoCorp on 07-Nov-2022

Award received under the category "Best In Innovation & Technology" at the Hero – NEXT 22.

TATA MOTORS
ANNUAL SUPPLIER CONFERENCE 2022

GOING EXTRA MILE
PRICOL LIMITED

Award From TATA Motors (TML) on 07-Sep-2022

Award received under the category "GOING EXTRA MILE" for our proactive and extending support to TML amidst difficult situations.



Reformation
thru Partnership



Award From Suzuki Motorcycle India Limited (SMIL) on 03-Jun-2022

Award received under the category "New Development 2022" for our proactive approach on new developments and meeting the requirements amidst semiconductor scarcity across the globe

Other Awards



Confederation of Indian Industry

- Pricol has been recognized with the “Business Innovation” Award by CII Tamil Nadu for the various innovations done on Driver Information and Connected vehicle solutions.
- Pricol won prestigious Gold award at the 6th National Low Cost Automation Circle Competition 2023 organized by CII
- Pricol won prestigious Silver award at the 8th National Low Cost Automation Circle Competition 2024 organized by CII



Automotive Component Manufacturers Association of India

- Pricol won 3rd position in the 9th Kaizen Contest
- Pricol won 1st & 2nd position in the 19th Quality Circle Competition (West Region)
- Pricol won 3rd position in the 21st Regional Quality Circle Competition (North Circle)



- Pricol won the Four Gold award at the 39th Annual Chapter Convention on Quality Concepts at Pune
- Pricol won the prestigious Gold award at the 8th Chapter Convention on Quality Concepts
- Pricol won the prestigious Gold award at the 34th Quality Circle Convention – Delhi Chapter NCR Region
- Pricol won the prestigious “EXCELLENT AWARD” in 37th National Convention on Quality Concepts (NCQC 2023)



- Pricol received “First Prize” in the Quality Conclave
- Pricol won Silver award in the 12th Edition of Productivity Conclave
- Pricol has been honored with the “Safety Excellence Award” at the 7th Edition of the Safety Conclave

Select Recent
Product Launches

2W Recent Next – Gen DIS Launch



Honda

(QC1) **EV**



Honda

(Shine 125)



BAJAJ

(Chetak) **EV**



BAJAJ

(Pulsar NS400)



HMCL

(Mavrick 440)



HMCL

(VIDA – 7" TFT) **EV** 



TVS

(iQube - 7" TFT) **EV** 



TVS

(Apache 310 RTR – 5" TFT)

PV Recent Launch



TATA Motors

(Nexon)



Force Motors

(Gurkha)



TATA Motors

(Nexon and Tigor) **EV**



TATA Motors

(Punch)



TATA Motors

(Nexon)



TATA Motors

(Punch - Nova) **EV**

CV Recent Launch



Force Motors

(Urbania)



Switch Mobility

(leV3/4 Series) **EV**



TATA Motors

(12 & 24V - ERGO)



Ashok Leyland Limited

(New Generation CVs)



TATA Motors

(TATA Ace) **EV**



DAIMLER

(PRIME Model)

Export Recent Launch



Stellantis
(Ami) **EV**



NEW HOLLAND
(Instrument Cluster)

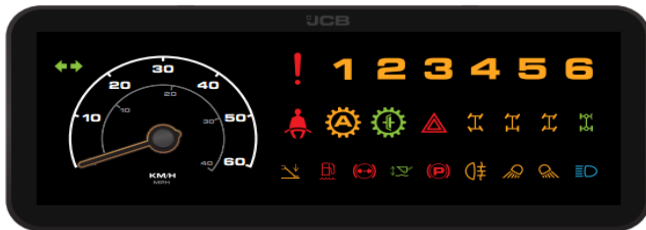

JCB
(Warning Cluster)



JCB
(7" TFT Instrument Cluster)

Pumps and Mechanical Products – Recent Launches

Variable Displacement – Vane Type Oil Pump

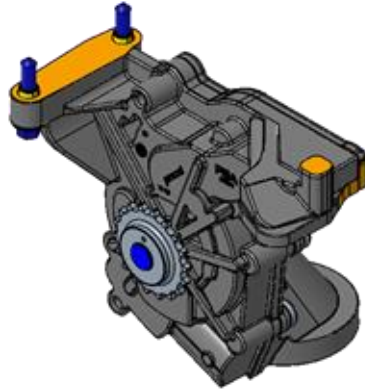

Stellantis

C5 AirCross

Oil Pump



Stellantis

C3 - PV

Water Pump

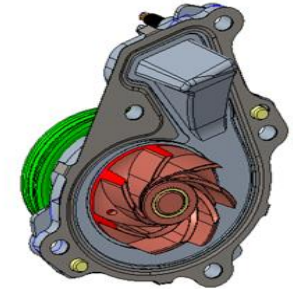

Stellantis

C3 - PV

Pumps and Mechanical Products – Recent Launches

Fuel Pumps



TVS

(Jupiter, Pep+)



HMCL

(Passion Pro, Glamour, Extreme)

Electronic Purge Valve



HMCL

(All BSVI Motorcycles & Scooters)

Export Recent Launch

Water Pumps



CAT

LPSD



Harley Davidson

LaMotta



BMW

K67 Water/ Oil pump

Oil Pumps

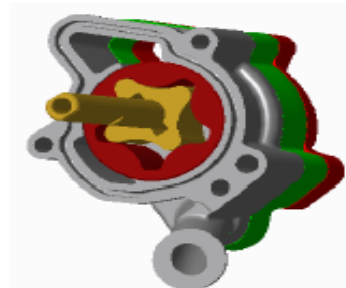

Harley Davidson

LaMotta



Ducati

Panigale

 *PASSIONATE*
 *SUSTAINABLE*
 *DYNAMIC*
 *EVOLVING*